

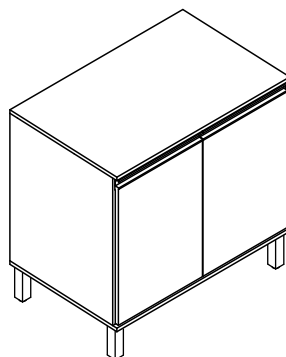

Rodovia SC-492 - Km 10 - B. Industrial
89905-000 - Bandeirante - SC
Fone: (49) 3622-4549
e-mail: mxmoveis@mxmoveis.com.br



Ref. BVI01

Balcão 800
Cozinha/Cocina
Vicenza

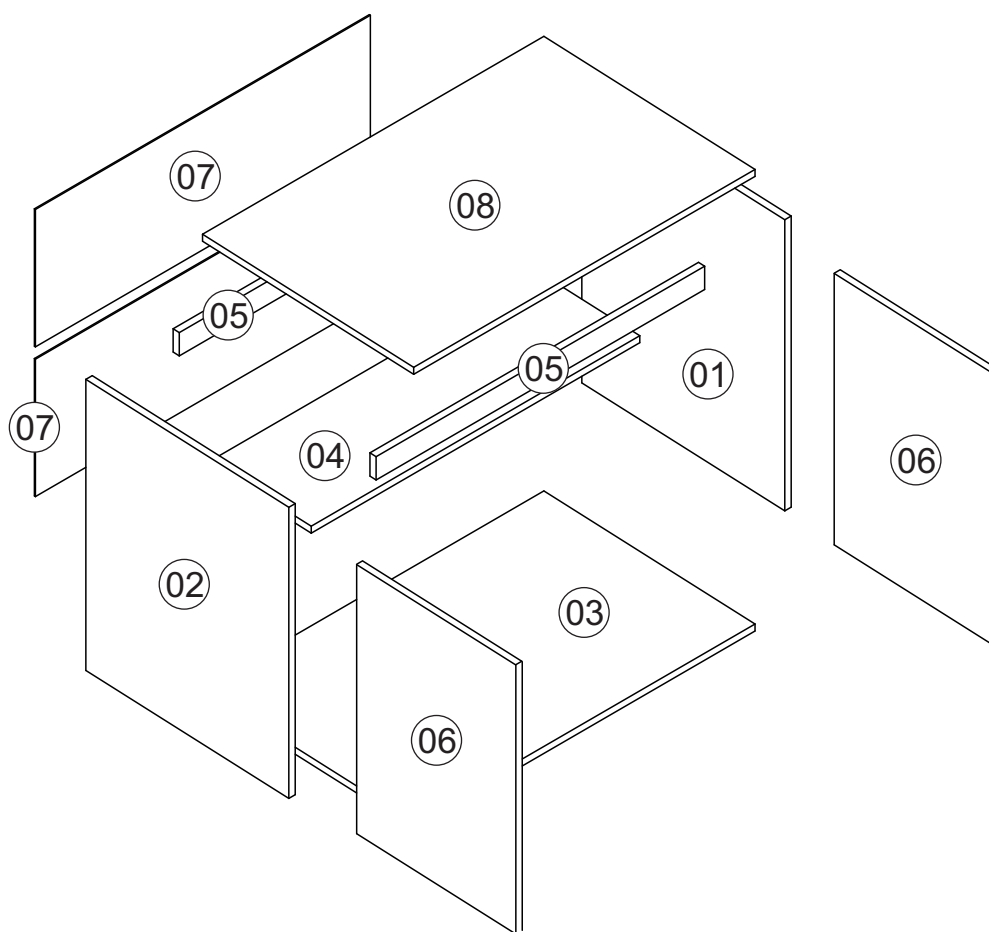

Nº	Código Assistência	NOME DA PEÇA/DESCRIPCIÓN PIEZAS		QTD.	HAVANA TAUPE	NOGAL NOGAL
01	BVI01.17.00	Lat. externa dir./Lateral derecha	625X496X15	01	165750	166770
02	BVI01.18.00	Lat. externa esq./Lateral izquierda	625X496X15	01	165751	166771
03	BVI01.01.00	Base inferior/Base inferior	800X516X15	01	165748	166768
04	BVI01.27.00	Prateleira interna/Repisa	770X250X15	01	136384	136384
05	BVI01.28.00	Ripa balcão/Traviesa balcón	770X50X15	02	165749	166769
06	BVI01.25.00	Porta balcão/Puerta balcón	580X389X15	02	160053	167556
07	BVI01.13.00	Forro/Revés	794X300X2,5	02	136387	136387
08	BVI01.33.00	Tampo/Tapa	800X516X15	01	177027	177027

Ferragens/Herrajes

A  **04x**
Cavilha Ø6,0x30mm Cód. 873

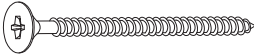
B  **08x**
Parafuso 4,0x50mm Cht. Cód. 12537

C  **02x**
Puxador/Manija 389mm Cód. 6554-preto
Cód. 820-bronze

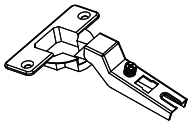
D  **04x**
Dobradiça Cód. 10269

E  **16x**
Parafuso 4,0x12mm Cht. Cód. 7604

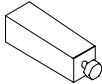
F  **04x**
Pé plástico Cód. 5884
Cód. 5883-preto

G  **16x**
Parafuso 3,0x12mm Cht. Cód. 11413

H  **04x**
Parafuso 5,0x50mm Cht. Cód. 1979

I  **05x**
Fixador costa Cód. 7169

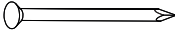
J  **25x**
Prego 8x8 Cód. 822

K  **06x**
Cantoneira metálica Cód. 7168

L  **08x**
Parafuso 3,5x25mm Cht. Cód. 692

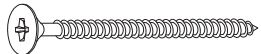

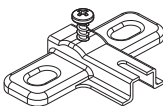
M  **04x**
Parafuso 3,5x40mm Cht. Cód. 691

N  **04x**
Calço dobradiça Cód. 12539

O  **04x**
Parafuso 4,0x14mm Cht. Cód. 667

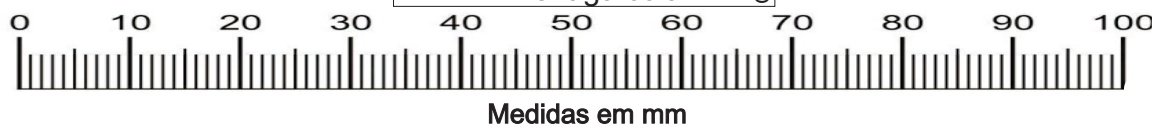
P  **01x**
Bisnaga cola Cód. 8255

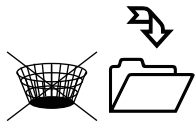
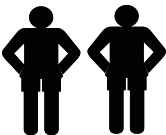

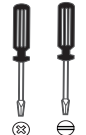
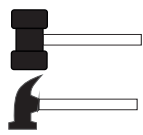
		 1:00		
---	---	---	---	---

 **Giz para madeira**
Produto para ser aplicado em caso de riscos na superfície

Pré-Montagem/Preparación Piezas

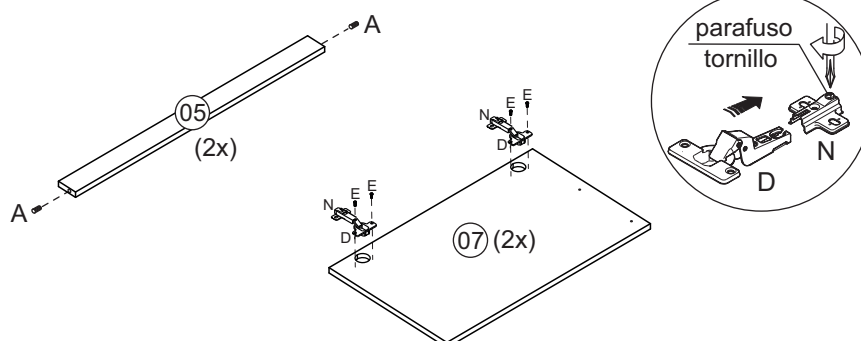

Montagem/Montaje

01

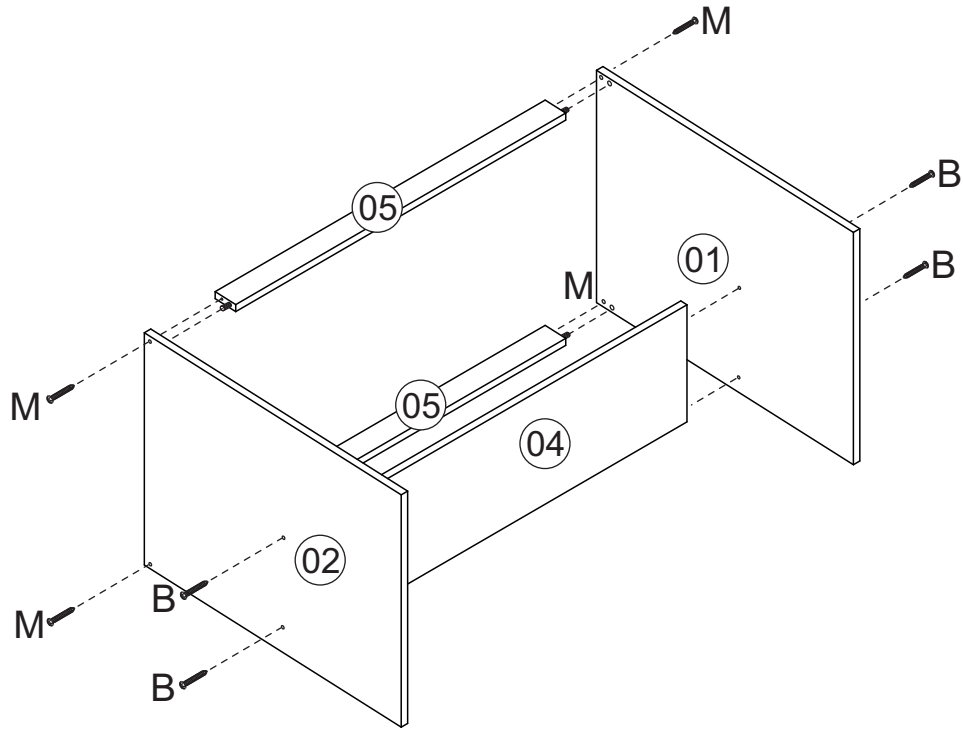

02

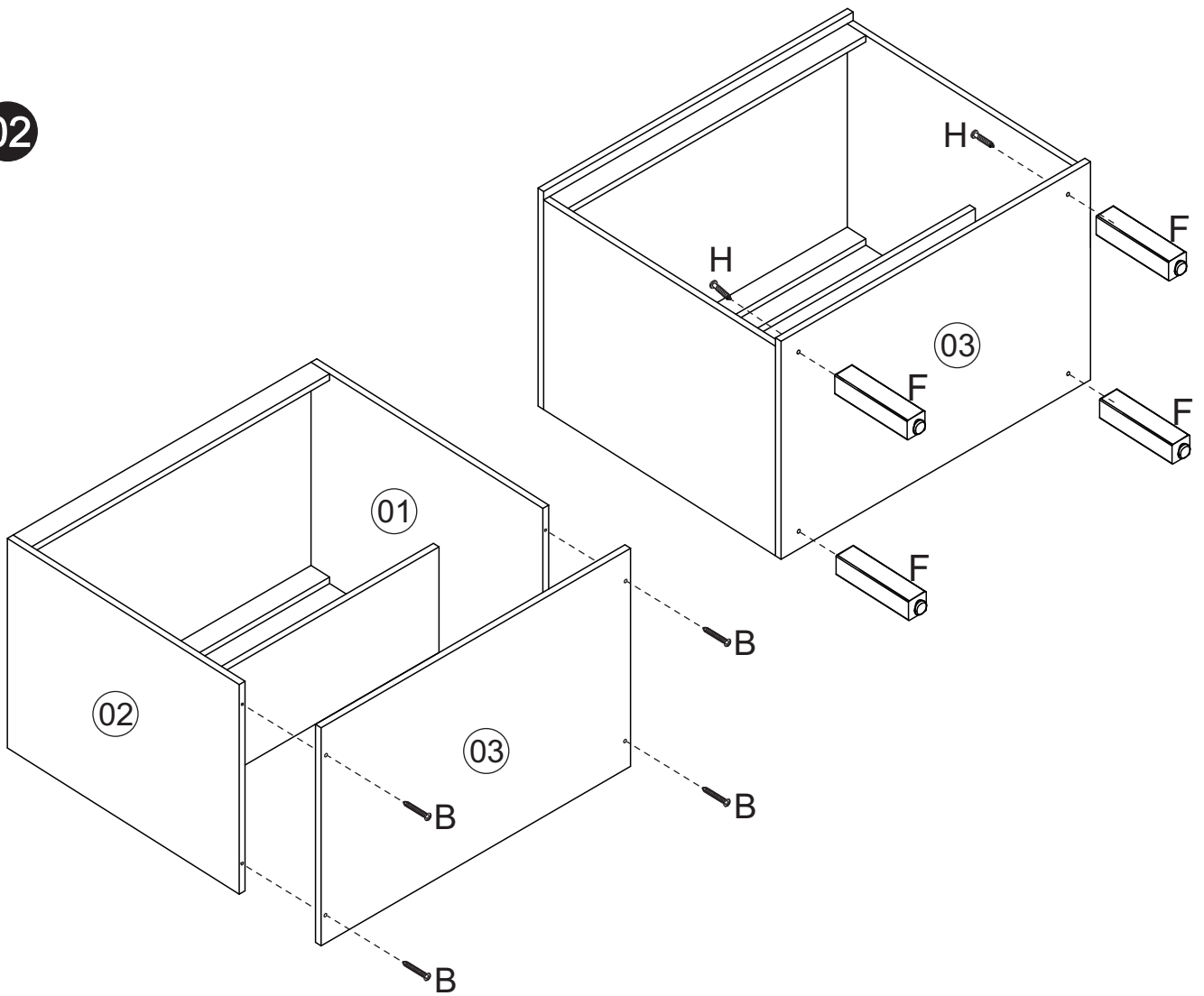

Montagem/Montaje

03

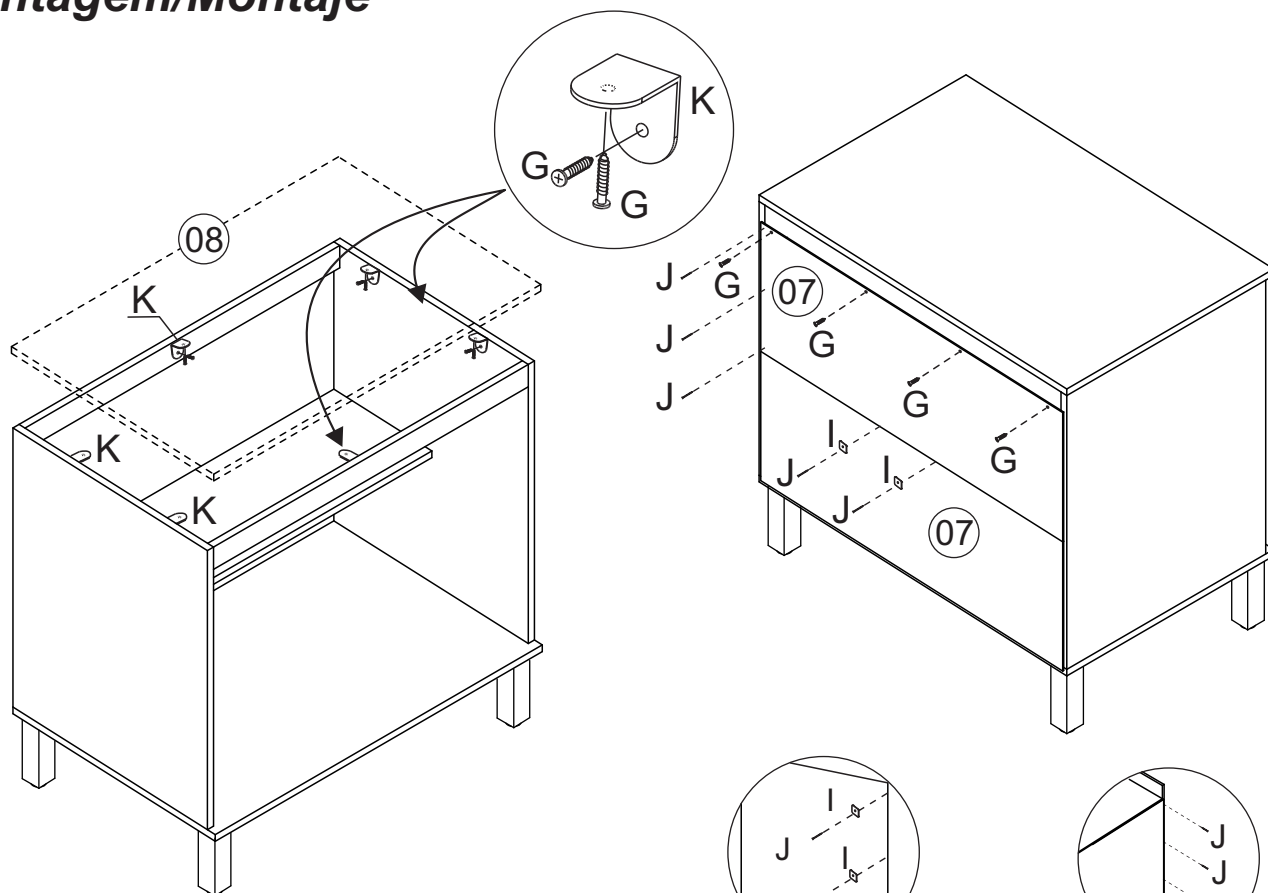

04

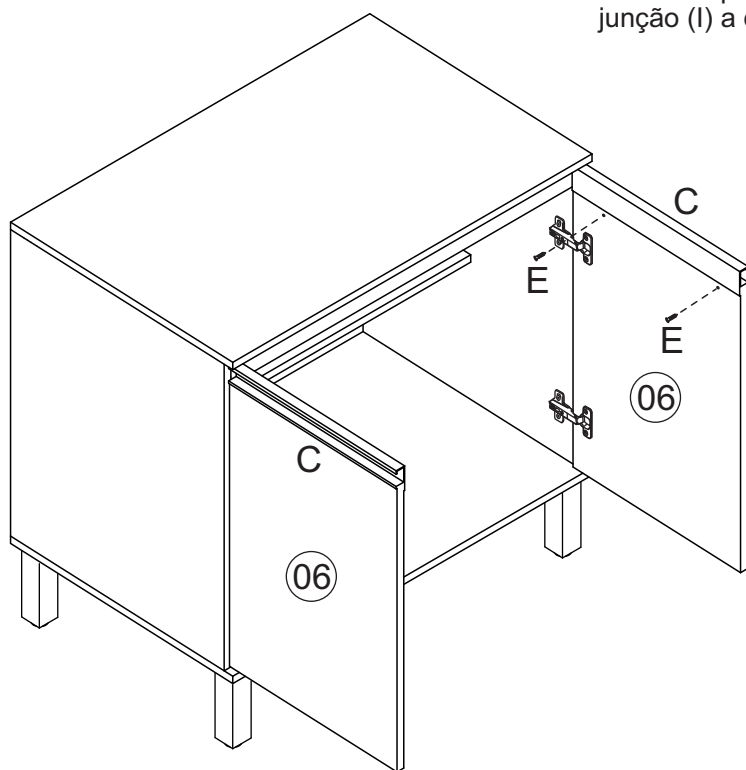

*Usar o prego (J) e a junção (I) a cada 150mm.

*Colocar um prego (J) a cada 100mm.

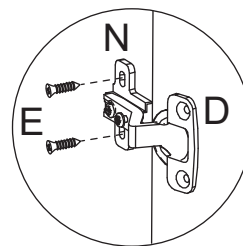

*Usar os parafusos (L) para unir este módulo a outro.
Usar los tornillos (L) para unirse este módulo a otro.



Limpeza/Limpieza

- ≠ Use um pano levemente umedecido com água, seguido de pano seco.
- ≠ Use solamente un paño húmedo con agua y después un paño seco.
- ≠ Nunca utilize produtos químicos ou abrasivos.
- ≠ No utilice productos químicos o abrasivos.